

**JMA-5208/HS**

**JMA-5212-4/6**

**JMA-5222-7/9**

**JMA-5212-4HS/6HS**

## **SIMPLIFIED MANUAL**

<b>1</b>	<b>INTRODUCTION</b> .....	<b>S-1</b>
1.1	READ ME .....	S-1
<b>2</b>	<b>BASIC OPERATION</b> .....	<b>S-2</b>
2.1	POWER ON AND START THE SYSTEM.....	S-2
2.2	END THE OPERATION AND POWER OFF.....	S-3
2.3	ADJUST MONITOR BRILLIANCE [BRILL].....	S-3
2.4	CHANGE OBSERVATION RANGE [RANGE + / - ].....	S-4
2.5	ADJUST GAIN [GAIN / PL] .....	S-4
2.6	SUPPRESS SEA CLUTTER [AUTO-SEA] .....	S-4
2.7	SUPPRESS RAIN / SNOW CLUTTER [AUTO-RAIN] .....	S-6
2.8	USING ELECTRONIC BEARING LINE (EBL1 / EBL2).....	S-7
2.9	USING VARIABLE RANGE MARKER (VRM1 / VRM2) .....	S-10
2.10	SWITCH TRANSMITTER PULSE LENGTH [GAIN / PL] .....	S-11
2.11	SWITCH AZIMUTH DISPLAY MODE [AZI MODE] .....	S-11
2.12	SWITCH TRUE / RELATIVE MOTION DISPLAY MODE [TM / RM] .....	S-12
2.13	DISPLAY RADAR TRAILS [TRAILS] .....	S-13
<b>3</b>	<b>TARGET TRACKING OPERATION</b> .....	<b>S-14</b>
3.1	ACQUIRING TARGET [ACQ] .....	S-14
3.2	DISPLAY TRACKED TARGET DATA [TGT DATA] .....	S-14
3.3	CANCELING TRACKED TARGETS [TGT CNCL].....	S-15
<b>4</b>	<b>AIS OPERATION</b> .....	<b>S-16</b>
4.1	SETTING AIS DISPLAY FUNCTION (AIS FUNCTION) .....	S-16
4.2	ACTIVATE AIS TARGETS (ACT AIS) .....	S-16
4.3	DISPLAY ACTIVATED AIS TARGET DATA [TGT DATA] .....	S-17
4.4	DEACTIVATE AIS TARGETS (DEACT AIS) .....	S-18
<b>5</b>	<b>TARGET TRACKING / AIS COMMON OPERATION</b> .....	<b>S-19</b>
5.1	SETTING VECTORS (VECTOR).....	S-19
5.2	SETTING COLLISION DECISION CRITERIA (CPA / TCPA LIMIT) .....	S-20
<b>6</b>	<b>OTHER CONTENTS</b> .....	<b>S-21</b>
6.1	RESET ALARM BUZZER [ALARM ACK] .....	S-21
6.2	OPERATION ON NUMERIC VALUE INPUT MENU .....	S-21



---

# 1 INTRODUCTION

## 1.1 Read Me

### About this manual

See the INSTRUCTION MANUAL for details.

Maintain this SIMPLIFIED MANUAL so that operators can refer to it at anytime.

### About radar equipment

Use the radar only as a navigation aid. The final navigation decision must always be made by the operator him/herself. Making the final navigation decision based only on the radar display may cause accidents such as collisions or running aground.

### About sea clutter suppression

When using the sea clutter suppression function, never set the suppression level too high canceling out all image noises from the sea surface at close range.

Detection of not only echoes from waves but also targets such as other ships or dangerous objects will become inhibited.

When using the sea clutter suppression function function, make sure to choose the most appropriate image noise suppression level.

### About rain/snow clutter suppression

When using the rain/snow clutter suppression function function, never set the suppression level too high canceling out all image noises from the rain or snow at close range.

Detection of not only echoes from the rain or snow but also targets such as other ships or dangerous objects will become inhibited.

When using the rain/snow clutter suppression function function, make sure to choose the most appropriate image noise suppression level.

### About target tracking (TT) function

Use target tracking function only as a navigation aid. The final navigation decision must always be made by the operator him/herself. Making the final navigation decision based only on tracking target information may cause accidents.

Tracked target information such as vector, target numerical data, and alarms may contain some errors. Also, targets that are not detected by the radar cannot be acquired or tracked.

Making the final navigation decision based only on the radar display may cause accidents such as collisions or running aground.

## 2 BASIC OPERATION

### 2.1 Power ON and Start the System

#### Procedures

- 1 Check that the ship's mains are turned on.
- 2 Press the [STBY] key.

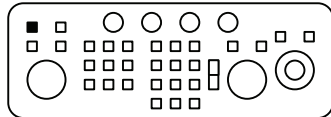

The system is turned on, and the preheating time is displayed. **Preheat** is indicated upper left of the display.

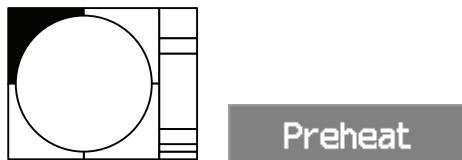

- 3 Wait until the preheating time is over.

When the preheating time is over, the preheating time screen disappears, and **Preheat** upper left of the display changes to **Standby**.

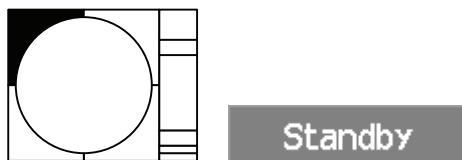

- 4 Press the [TX / PRF] key.

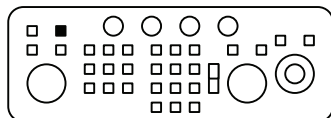

The radar will start transmission and the antenna will start rotating. **Standby** upper left of the display changes to **Transmit**.

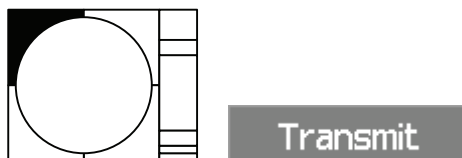

---

## 2.2 End the Operation and Power Off

### Exit

- 1 Press the [STBY] key.

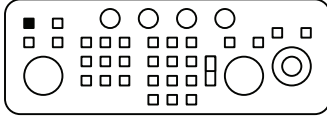

The radar will stop transmission and the antenna will stop rotating.

**Transmit** upper left of the display changes to **Standby**.

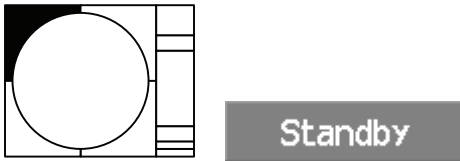

- 2 Press the [STBY] key and the [TX / PRF] key together.

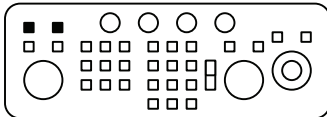

The system will be turned off.

## 2.3 Adjust Monitor Brilliance [BRILL]

### Procedures

- 1 Obtain the best-to-see display with optimum brilliance by turning the [BRILL] dial at the lower right of the LCD monitor unit.

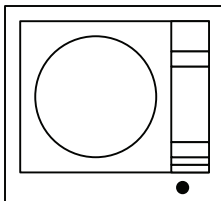

In consideration of the ambient brightness, adjust LCD monitor brilliance that is high enough to easily observe the radar display but does not glare.

## 2.4 Change Observation Range [RANGE + / - ]

### Procedures

- 1 When increasing the observation range, press the [RANGE+] key.

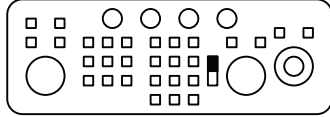

Increasing the observation range will enable a wider range to be observed.

- 2 When decreasing the observation range, press the [RANGE-] key.

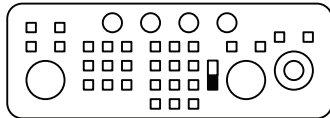

Decreasing the observation range will enable a narrower range to be observed.

## 2.5 Adjust Gain [GAIN / PL]

### Procedures

- 1 Turning the [GAIN / PL] dial.

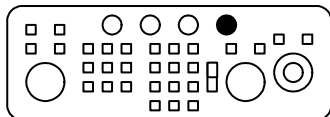

By increasing receiving gain, the range to observe radar video is widened.

## 2.6 Suppress Sea Clutter [AUTO-SEA]

### Using the manual sea clutter suppression mode

### Procedures

- 1 Turning the [AUTO-SEA] dial.

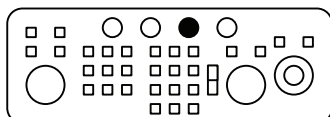

The sea clutter suppression function suppresses sea clutter returns by decreasing the receiving gain on a short range.

---

## Using the automatic sea clutter suppression mode

### Procedures

- 1 Press the [AUTO-SEA] dial.

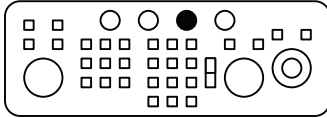

The automatic sea clutter suppression mode is selected, and **AUTO** is displayed in sea clutter suppression (Sea) mode switching.



- 2 Make adjustments by turning the [AUTO-SEA] dial.

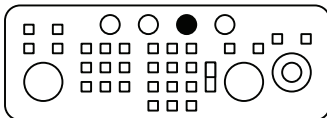

Even when the automatic sea clutter suppression mode is selected, turning the [AUTO-SEA] dial can make fine adjustments manually.

### Cancellation

- 1 Press the [AUTO-SEA] dial.

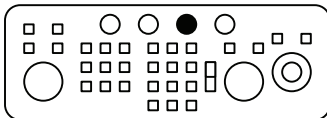

The automatic sea clutter suppression mode is cancelled, and **MAN** is displayed in the sea clutter suppression (Sea) mode field.



## 2.7 Suppress Rain / Snow Clutter [AUTO-RAIN]

### Using the manual rain / snow clutter suppression mode

#### Procedures

##### 1 Turning the [AUTO-RAIN] dial.

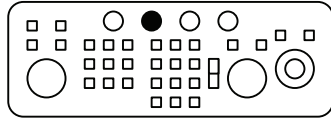

The rain / snow clutter suppression function suppress rain / snow clutter returns by decreasing the receiving gain.

Since the rain / snow clutter suppression function also has the effect of suppressing sea clutter, the suppression efficiency improves when the [AUTO-RAIN] dial is used with the [AUTO-SEA] dial.

### Using the automatic rain / snow clutter suppression mode

#### Procedures

##### 1 Press the [AUTO-RAIN] dial.

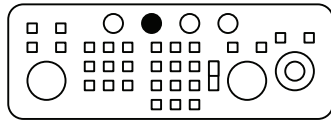

The automatic rain / snow clutter suppression mode is selected, and **AUTO** is displayed in the sea clutter suppression (Sea) mode switching and the rain / snow clutter suppression (Rain) mode switching.



##### 2 Make adjustments by turning the [AUTO-RAIN] dial and the [AUTO-SEA] dial.

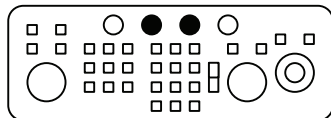

Even when the automatic rain / snow clutter suppression mode is selected, turning the [AUTO-RAIN] dial and the [AUTO-SEA] dial can make fine adjustments manually.



## Cancellation

### 1 Press the [RAIN] dial.

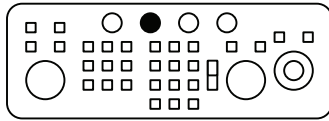

The automatic rain / snow clutter suppression mode is cancelled, and **AUTO** is changed to **MAN** in the sea clutter suppression (Sea) mode field and the rain / snow clutter suppression (Rain) mode field.



## 2.8 Using Electronic Bearing Line (EBL1 / EBL2)

### [I] Operating EBL (EBL)

#### Procedures

### 1 Press the [EBL1] or [EBL2] key.

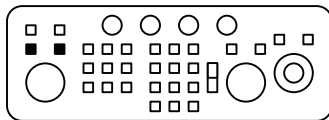

The EBL adjustment will be highlighted, and the selected EBL becomes operable.

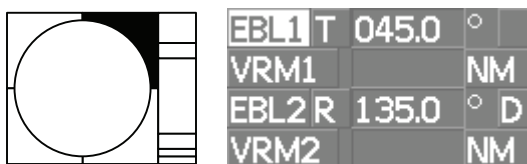

### 2 Turn the [EBL] dial.

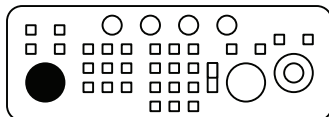

To turn the **[EBL]** dial to the right, turn the EBL dial clockwise, to turn the **[EBL]** dial to the left, turn the EBL dial counterclockwise.

## Cancellation

- 1 Press the [EBL1] or [EBL2] key again.

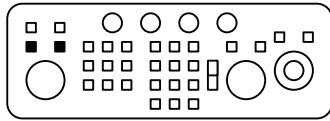

The selected EBL display will disappear.

## [III] Moving the Starting Point of EBL

The system provides three types of EBL starting points. Select one of them in accordance with purpose.

- : The EBL starting point is defined as the own ship's position.
- C : The EBL starting point is moved and fixed on the radar display.
- D : The EBL starting point is moved and fixed at the latitude and longitude.

### To move the starting point of EBL

#### Procedures

- 1 Hold down [EBL] control.

The Jog Dial Button Mode will appear

- 2 Select 2 Floating EBL using Left Jog Dial, and set Floating EBL for Left Jog Dial Mode.
- 3 When setting completes, EBL1 or EBL2 become operable
- 4 Press the [EBL] dial to set  C or  D for the EBL1 / EBL2 starting point mode switching.

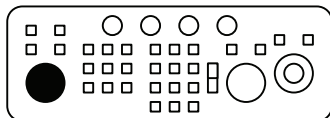

The selected EBL starting point mode is switched as shown below each time the dial is pressed.

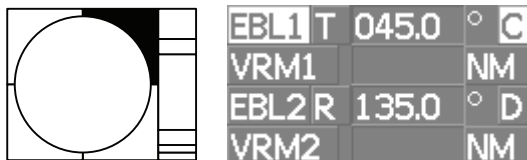

- 5 Put the cursor on the EBL starting point is to be moved, and press the [ENT] key.

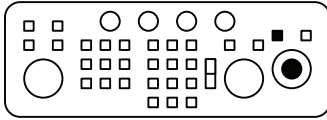

The selected EBL starting point will be determined.

**To return the EBL starting point to own ship's position**

**Procedures**

- 1 Hold down [EBL] control.

The Jog Dial Button Mode will appear

- 2 Select 2 Floating EBL using Left Jog Dial, and set Floating EBL for Left Jog Dial Mode.
- 3 When setting completes, EBL1 or EBL2 become operable
- 4 Press the [EBL] dial to set  for the EBL1 / EBL2 starting point mode switching.

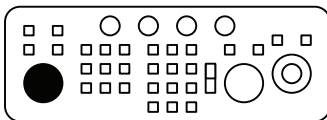

The selected EBL starting point will be set as the own ship's position.

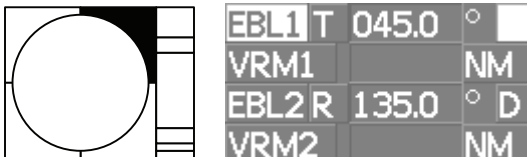

## 2.9 Using Variable Range Marker (VRM1 / VRM2)

### To operate VRM

#### Procedures

- 1 Press the [VRM1] or [VRM2] key.

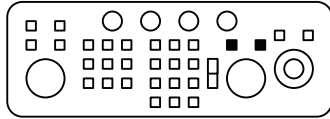

The VRM adjustment will be highlighted, and the selected VRM becomes operable.

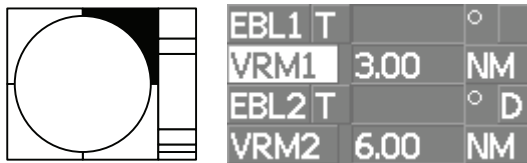

- 2 Turn the [VRM] dial.

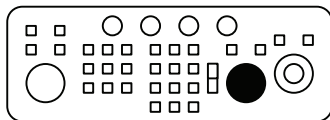

To turn the [VRM] dial to the right, the VRM control wide, to turn the [VRM] dial to the left, the VRM control narrow.

#### Cancellation

- 1 Press the [VRM1] or [VRM2] key again.

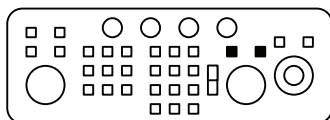

The selected VRM display will disappear.

---

## 2.10 Switch Transmitter Pulse Length [GAIN / PL]

### Procedures

- 1 Press the [GAIN / PL] dial.

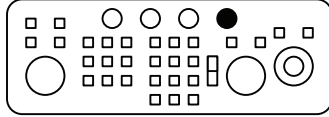

The selected pulse length will be displayed in the pulse length indication.

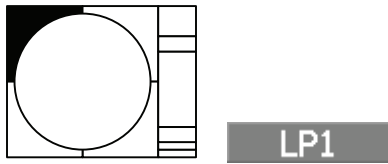

## 2.11 Switch Azimuth Display Mode [AZI MODE]

### Procedures

- 1 Press the [AZI MODE] key.

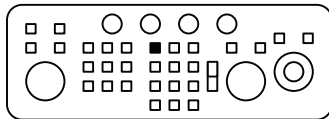

The azimuth display modes are switched.

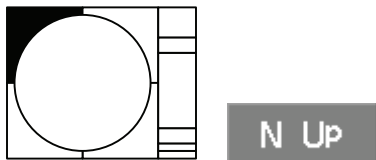

## 2.12 Switch True / Relative Motion Display Mode [TM / RM]

### Switching Motion Display Mode

#### Procedures

- 1 Press the [TM / RM] key.

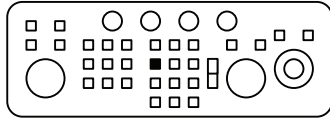

The motion display mode are switched.

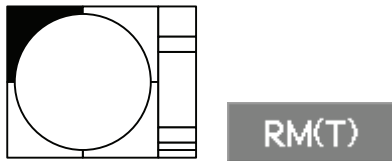

### Resetting Own Ship to its Initial Position in True Motion (TM) Mode

#### Procedures

- 1 Press the [TM / RM] key for 2 seconds.

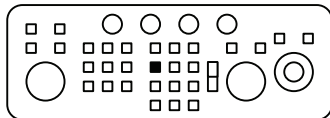

Own ship will be reset to its initial position as established when the relative motion mode is changed to the true motion mode. The ship starts moving from that position.

---

## 2.13 Display Radar Trails [TRAILS]

### Changing the length of the trail

#### Procedures

- 1 Press the [TRAILS] key.

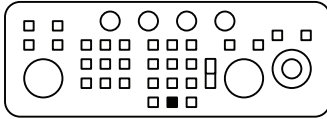

Values of the length of the radar trail are switched.

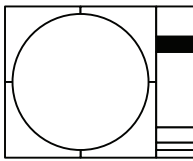

### Erasing Trails Data

#### Procedures

- 1 Press the [TRAILS] key for 5 seconds.

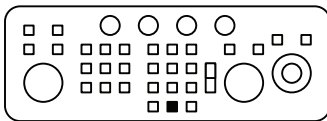

All the saved trails data will be erased. The system starts plotting trails in initial state. If [TRAILS] key is pressed for 2 seconds, the RADAR Trails Setting menu is opened. Furthermore, data will be erased if it continues pressing.

### Changing Motion Mode of Trails (Trails mode)

#### Procedures

- 1 Put the cursor on radar trails display true **T** / relative **R** switching, and press the [ENT] key.

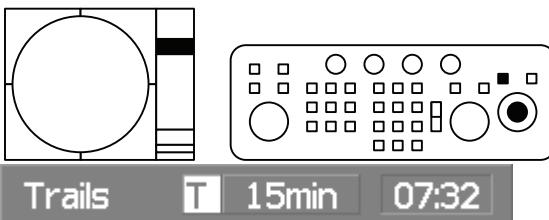

The trails motion modes are switched. If true motion (TM) mode is selected in azimuth display mode, only the true motion trails mode is available.

## 3 TARGET TRACKING OPERATION

### 3.1 Acquiring Target [ACQ]

#### Procedures

- 1 Put the cursor on the target to be acquired, and press the [ACQ] key.

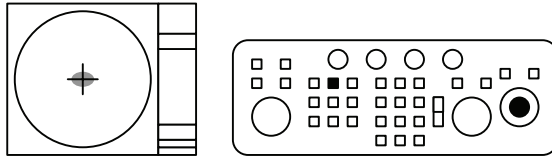

The target will be acquired and the initial acquisition symbol will be displayed. The vector will be displayed within one minute.

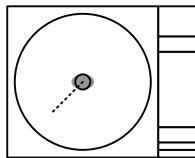

### 3.2 Display Tracked Target Data [TGT DATA]

#### Procedures

- 1 Put the cursor on the tracked target for which numeric data is to be displayed, and press the [TGT DATA] key.

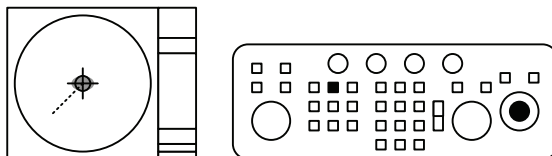

The data of the selected target will be displayed.

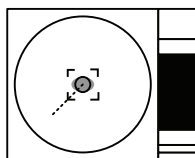



---

### 3.3 Canceling Tracked Targets [TGT CNCL]

#### Canceling targets one by one [TGT CNCL]

##### **Procedures**

- 1 Put the cursor on the tracked target to the desired for canceling target, and press the [TGT CNCL] key.

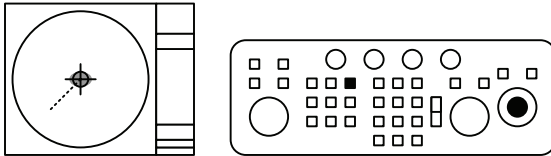

The vectors and symbols of the tracked targets will disappear, and only the radar video remain.

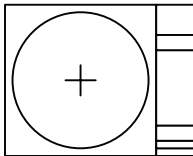

#### Canceling all targets collectively [TGT CNCL]

##### **Procedures**

- 1 Press the [TGT CNCL] key for 5 seconds.

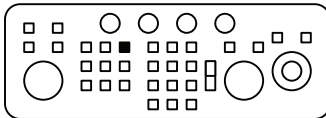

The vectors and symbols of all the targets will disappear, and only the radar video remain.

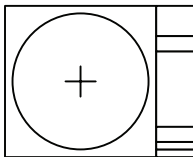

## 4 AIS OPERATION

### 4.1 Setting AIS Display Function (AIS Function)

#### Procedures

- 1 Put the cursor on the AIS On / Off **AIS**, and press the [ENT] key.

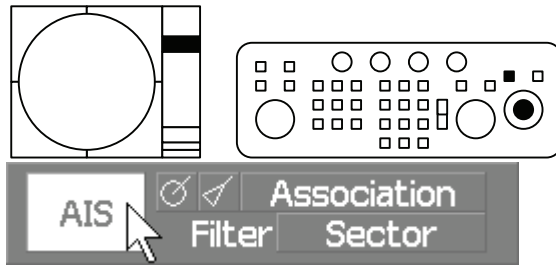

The received AIS information will be shown on the radar display.

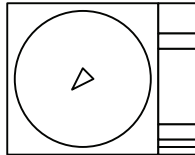

### 4.2 Activate AIS Targets (ACT AIS)

#### Procedures

- 1 Set the cursor mode to ACT AIS.

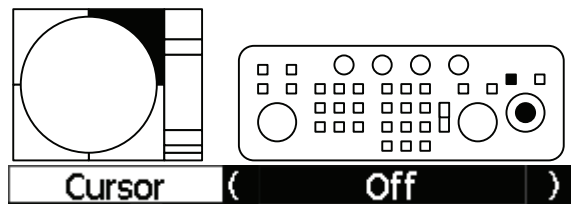

The cursor mode will appear as ACT AIS.



- 
- 2 Put the cursor on the AIS target to be activated, and press the [ENT] key.

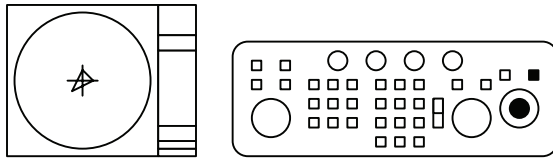

The selected AIS target will be activated.

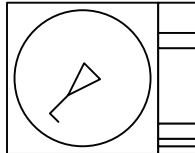

### 4.3 Display Activated AIS Target Data[TGT DATA]

#### Procedures

- 1 Put the cursor on the AIS target of which data is to be displayed, and press the [TGT DATA] key.

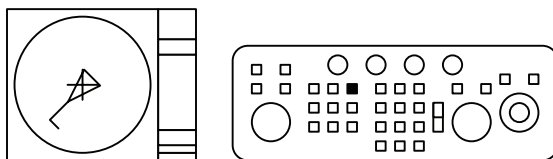

The data of the selected AIS target will be displayed.

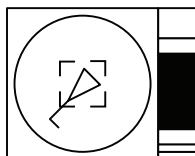

## 4.4 Deactivate AIS Targets (DEACT AIS)

### Procedures

- 1 Set the cursor mode to ACT AIS.

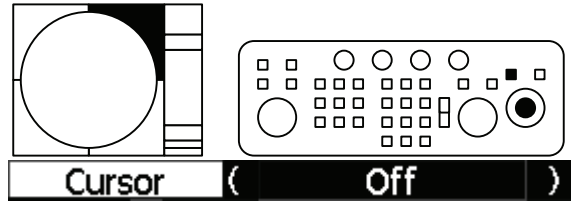

The cursor mode will appear as ACT AIS.



- 2 Put the cursor on the activated AIS target to be deactivated, and press the [CLR/INFO] key.

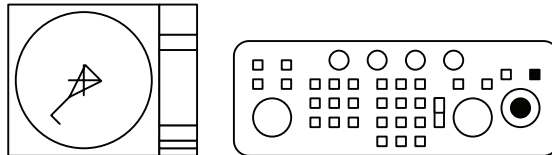

The selected AIS target will be deactivated.

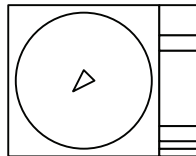

---

# 5 TARGET TRACKING / AIS COMMON OPERATION

## 5.1 Setting Vectors (Vector)

### Setting vector mode [VECT R / T]

#### Procedures

- 1 Press the [VECT R / T] key.

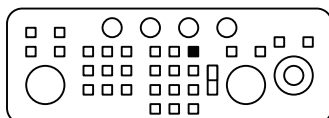

The current vector mode **T** (true vector) or **R** (relative vector) will be displayed in the target vector display true / relative switching.



### Setting vector time on the display (Vector Time)

#### Procedures

- 1 Put the cursor on the target vector time setting, and press the [ENT] key.

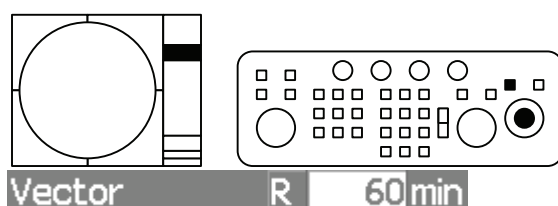

The Vector Time value input screen will appear.

- 2 Enter the value to be set as vector time.

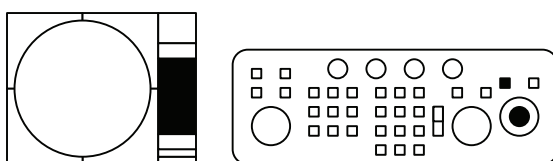

For how to input numeric data on the numeric value input menu, see Section 6.2.

## 5.2 Setting Collision Decision Criteria (CPA / TCPA limit)

### Input of CPA Limit

#### Procedures

- 1 Put the cursor on the CPA limit setting, and press the [ENT] key.

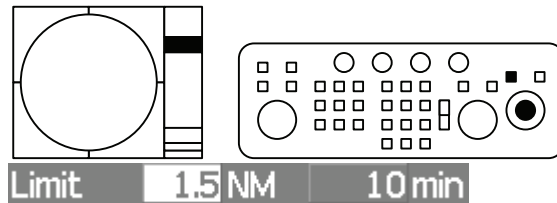

The CPA Limit value input screen will appear.

- 2 Enter the value to be set as a CPA limit.

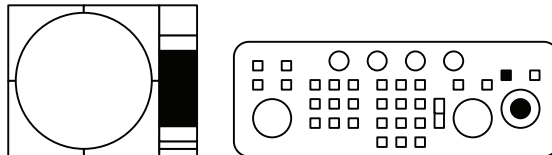

For how to input numeric data on the numeric value input menu, see Section 6.2.

### Input of TCPA Limit

#### Procedures

- 1 Put the cursor on the TCPA limit setting, and press the [ENT] key.

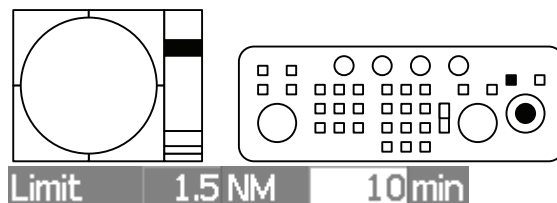

The TCPA Limit value input screen will appear.

- 2 Enter the value to be set as a TCPA limit.

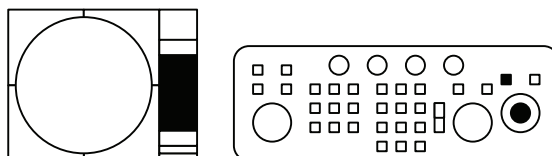

For how to input numeric data on the numeric value input menu, see Section 6.2.

---

## 6 OTHER CONTENTS

### 6.1 Reset Alarm Buzzer [ALARM ACK]

#### Procedures

- 1 Press the [ALARM ACK] key.

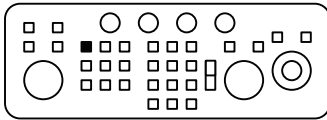

The alarm will stop buzzing.

### 6.2 Operation on Numeric Value Input menu

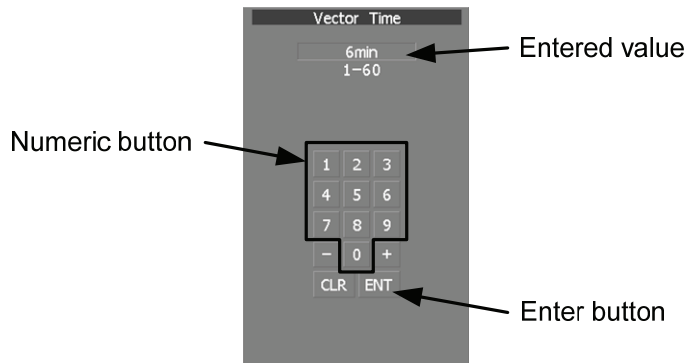

#### Procedures

- 1 Put the cursor on the numeric button to the desired value, and press the [ENT] key.

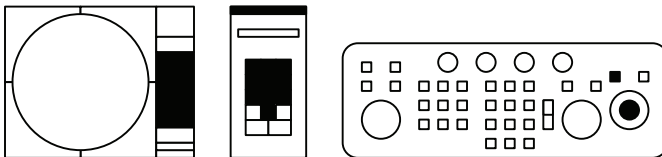

- 2 Make sure that the entered value is correct, put the cursor on the enter button [ENT], and then press the [ENT] key.

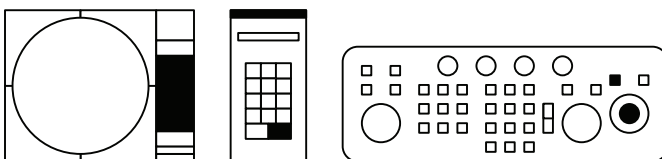

The set value is reflected to the operating state.











アスベストは使用しておりません  
Not use the asbestos

CODE No.7ZPRD0718

For further information, contact:



*Japan Radio Co., Ltd.*

Since 1915

URL <http://www.jrc.co.jp>

Marine Service Department

Telephone : +81-3-3492-1305

Facsimile : +81-3-3779-1420

e-mail : [tmsc@jrc.co.jp](mailto:tmsc@jrc.co.jp)

AMSTERDAM Branch

Telephone : +31-20-658-0750

Facsimile : +31-20-658-0755

e-mail : [service@jrcams.nl](mailto:service@jrcams.nl)

SEATTLE Branch

Telephone : +1-206-654-5644

Facsimile : +1-206-654-7030

e-mail : [service@jrcamerica.com](mailto:service@jrcamerica.com)

01ETM

ISO 9001, ISO 14001 Certified

©MAR. 2010 Edition 2

JRC

Printed in Japan